

Fig. 1

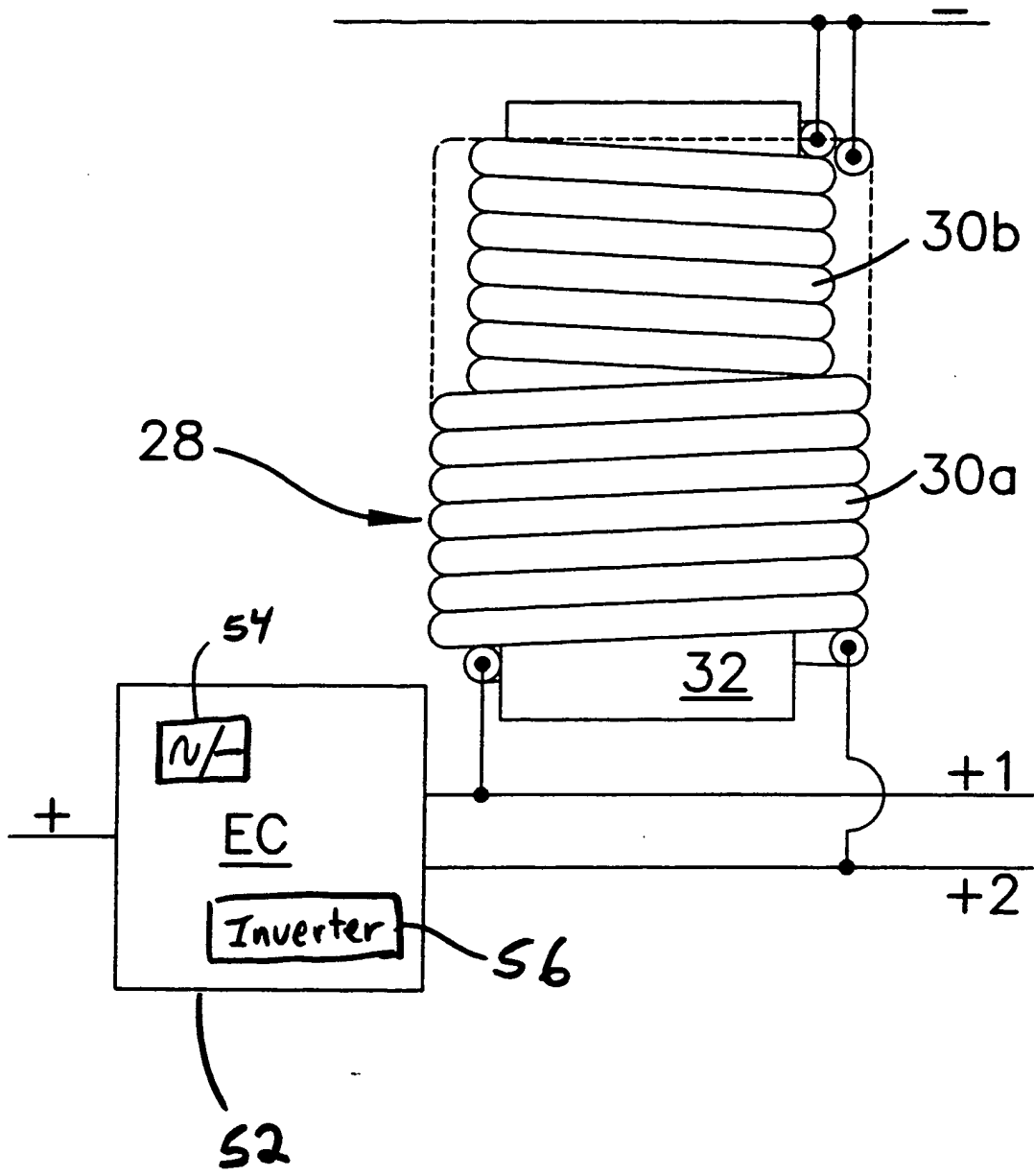

Fig.6